

Librem 5

Quick Start Guide

Important Notice

Please read carefully before you continue.

Purism SPC provides the enclosed product(s) under the following conditions:

This development board/kit/module is intended for use for ENGINEERING DEVELOPMENT, DEMONSTRATION OR EVALUATION PURPOSES ONLY and is not considered by Purism SPC to be a finished end-product fit for general consumer use. Persons handling the product must have electronics training and observe good engineering practice standards. As such the goods being provided are not intended to be complete in terms of required design-, marketing-, and/or manufacturing related protective considerations, including product safety and environmental measures typically found in the products that incorporate such semiconductor components or circuit boards. This development board/kit/module does not fall within the scope of the European Union directives regarding electromagnetic compatibility, FCC, CE or UL and therefore may not meet the technical requirements of these directives or other related documents.

The user assumes all responsibility and liability for proper and safe handling of the goods. Further, the user indemnifies Purism SPC from all claims arising from the handling or use of the goods. Due to the open construction of the product, it's the user's responsibility to take any and all appropriate precautions with regard to electrostatic discharge, conducted and radiated emissions.

EXCEPT TO THE EXTENT OF THE INDEMNITY SET FORTH ABOVE NEITHER PARTY SHALL BE LIABLE TO THE OTHER FOR ANY INDIRECT SPECIAL INCIDENTAL OR CONSEQUENTIAL DAMAGES.

Purism SPC provides a limited warranty of 6 months against manufacturing defects. The device is assembled and tested in the United States of America (USA).

If you do not agree to the above terms then do not unpack/use the board/kit/module and return the product as-is for a full refund.

Package Contents

The Librem 5 is supplied with the following components and accessories:

- Battery (installed)
- Tray for nano-SIM and microSD cards (removable)
- SIM tray extraction tool
- USB-C cable
- Wall power adapter

If any of these are missing, please contact Purism support for guidance.

You Will Also Need

You will need to provide:

- A nano-SIM card
- A microSD card (optional)

The nano-SIM card is supplied by your mobile network provider.

You can use a microSD card to add additional storage to the phone.

Install the nano-SIM and microSD Cards

The phone accepts nano-SIM and microSD cards in a tray next to the kill switches.

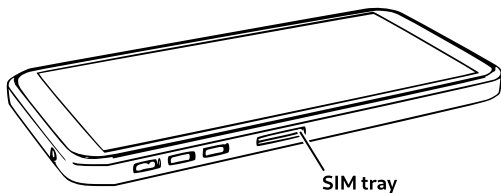

To open the tray, insert the point of the extraction tool into the hole at the right hand end of the tray.

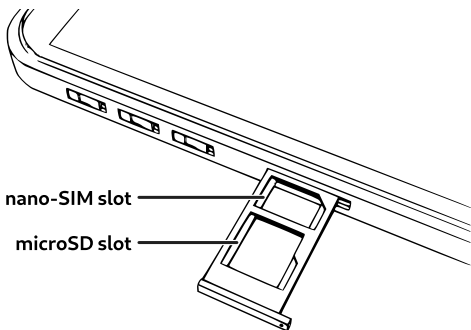

To install the cards:

1. Insert the nano-SIM card into the tray
2. Insert a microSD card into the tray (optional)
3. Insert the tray into the socket

The tray should click into place when closed.

Charge the Phone

You need to charge the phone before use:

1. Plug the charger into a suitable wall power outlet
2. Place the phone on a flat, hard, level surface
3. Connect the phone to the charger via the USB cable provided

The indicator light should appear red to show that the phone is charging. It will turn off again when the phone is fully charged.

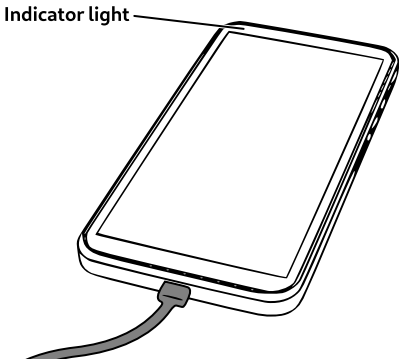

4. Leave the phone to charge for an hour
5. Unplug the charger from the power outlet
6. Unplug the USB cable from the phone

For troubleshooting hints and tips, go online to https://docs.puri.sm/Librem_5/Troubleshooting.html

Power on the Phone

Enable the Modem and WLAN by pushing those switches away from the SIM slot, as shown.

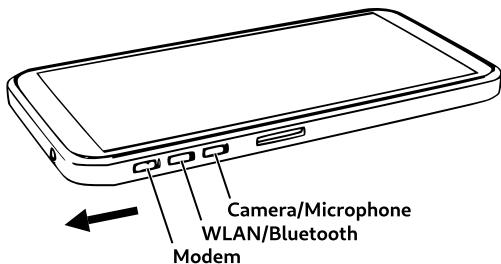

Ensure that the screen is visible.

Locate the power button.

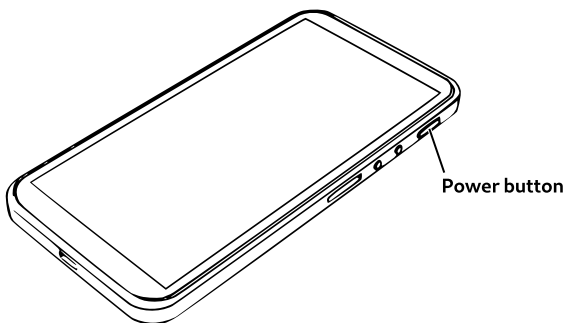

Hold down the power button until the screen lights up.

Unlock the Screen

The phone will show a lock screen.

To unlock it, swipe up from the bottom of the screen to reveal the passcode entry screen.

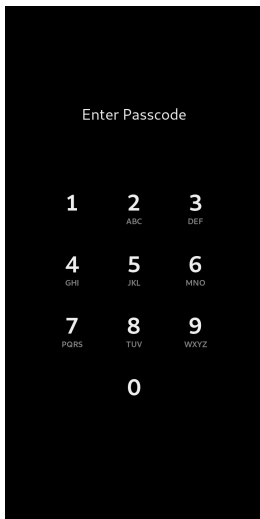
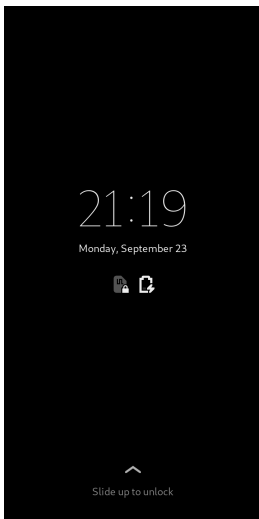

Enter the default six digit passcode – 123456 – using the numeric keypad.

When you have entered the passcode the phone will unlock.

You will be able to change the passcode later.

Initial Setup

The setup application starts with a **Welcome** screen.

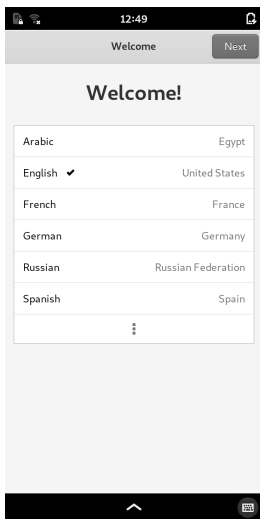

Select the language that you wish to use.

If your language is not shown, expand the list to show more languages by pressing the  (view more) icon at the bottom of the list.

Press the **Next** button to continue.

Text Input

The **Typing** page shows a selection of keyboards that are relevant to your language.

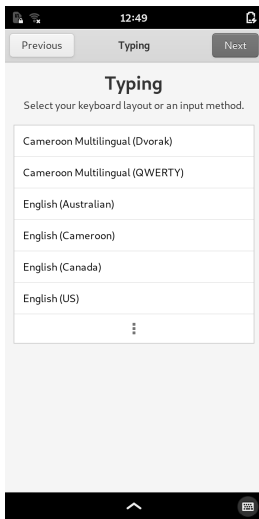

Select the keyboard that you want to use.
Expand the list to find the one you want, if necessary.
Press the **Next** button to continue.

Wireless Internet

If the WLAN switch is enabled, the **Network** page is shown. This lets you configure your wireless connection to the network.

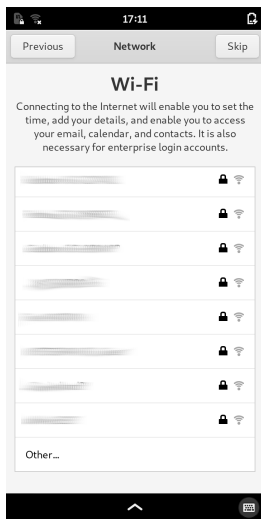

The WLAN interface may take a few seconds to list nearby wireless networks.

Select a network to begin the connection process, or swipe the list upwards to find the **Other...** item at the bottom of the list. Select this to connect to a hidden network.

Privacy

The **Privacy** page lets you opt-in to services that may be useful to you.

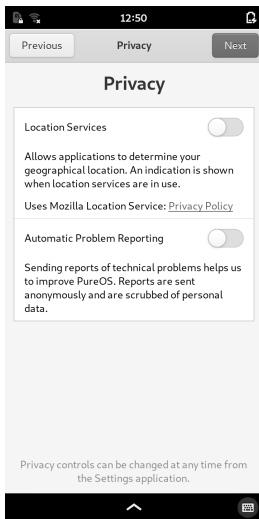

You don't have to accept the use of these. You can enable the services you want, or leave all of them disabled.

Press the **Next** button to continue.

Online Accounts

This page allows you to configure connections to any existing online accounts you may have. These are typically services that store contacts, e-mail or calendar information.

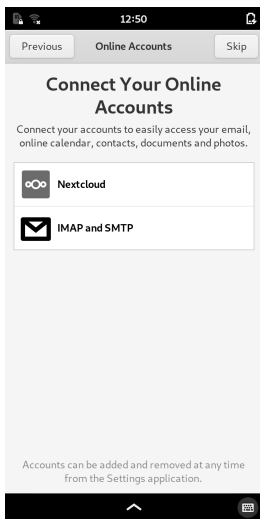

If you want to set up accounts now, select each one in turn and follow the instructions, or just press the **Skip** button to show the final page.

Press the **Start Using your Librem 5** button to continue.

Open the Settings

The next thing to do is to change the default passcode. This is done in the **Settings** application.

You should see a selection of applications on the screen.



Tap the **Settings** icon to open the application.

Select the **Details** category in the list of settings, then select **Users**.

Change your Passcode

The **Users** page lets you change information about your user account on the phone.

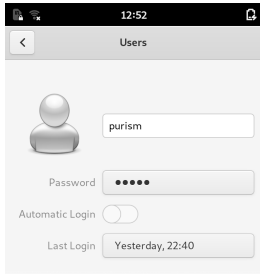

Tap the button containing the hidden text, next to the **Password** label.

This opens the **Change Password** dialog.

Enter your old passcode in the **Current Password** field.

Enter your new passcode in both the **New Password** and **Confirm** fields.

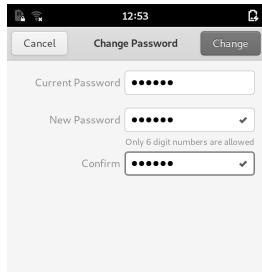

Press the **Change** button at the top-right of the screen to save the new passcode.

User Guide

The Librem 5 User Guide contains more information about the operating system and built-in applications.

It also includes introductory guides, including:

- An overview of the phone's user interface
- Connecting to a mobile network
- Placing and receiving calls
- Sending and receiving messages
- Setting up Wireless Internet
- Installing applications

The guide is provided as a collection of web pages on the phone, and can be accessed via an icon on the home screen.



It can also be viewed at https://docs.puri.sm/Librem_5.html

Support and compliance

The latest warranty details and policies related to hardware and services can be found at <https://puri.sm/policies/>

Should you encounter any software defects with the pre-installed PureOS, please report them at <https://tracker.pureos.net>

You can also ask questions and discuss with other users at <https://forums.puri.sm> or through support@puri.sm

Your Librem 5 ships with Free software where the source code is openly available under various freedom-respecting licenses. You are allowed (and encouraged!) to inspect, improve and redistribute it. You can obtain the source code for all the freed components of the system at <https://source.puri.sm/Librem5>

A summary of the software components which includes names, versions and descriptions, links to descriptions of corresponding source code, copyright and license information is part of the user guide, available at https://docs.puri.sm/Librem_5.html



©2019 Purism SPC

Quick Start Guide for the Librem 5 is licensed under a Creative Commons Attribution-ShareAlike 4.0 Unported License.

See <http://creativecommons.org/licenses/by-sa/4.0/>

Purism

1 Market Street
Spear Tower, 36th Floor
San Francisco, CA 94105
USA

<https://puri.sm>